



USER MANUAL

















MHS2510I/MHS2610I

Lift Scale



Please keep the instruction manual at hand all the time for future reference.

Explanation of Graphic Symbols on Label/Packaging

	<p>Caution, consult accompanying documents before use</p>		<p>Authorized representative in the European Community</p>
	<p>Manufacturer of medical device</p>		<p>Indicates that device conforms to International Organization of Legal Metrology (Class III) requirements</p>
	<p>Manufacturing year of medical device</p>		<p>Indicates that device conforms to 2014/31/EU Non Automatic Weighing Instruments Directive. Numerals change according to year of manufacture. (ex: "19" for 2019)</p>
	<p>Separate collection for waste of electrical and electronic equipment, in accordance with Directive 2002/96/EC</p>		<p>Indicates that device conforms to 93/42/EEC as amended by 2007/47/EC Medical Device Directive. Four digit number refers to Notified Body.</p>
	<p>Device catalogue number</p>		<p>Indicates that device conforms to 2014/31/EU Non Automatic Weighing Instruments Directive. Four digit number refers to Notified Body.</p>
	<p>Manufacturer's batch or lot number</p>		<p>Indicates that device is a medical device</p>
	<p>Serial number</p>		<p>Carefully read user manual before installation and usage, and follow instructions for use.</p>
	<p>Unique Device Identifier</p>		<p>Medical electrical equipment with Type B applied part</p>

Copyright Notice

Charder Electronic Co., Ltd.

No.103, Guozhong Rd., Dali Dist., Taichung City 41262 Taiwan

Tel: +886-4-2406 3766

Fax: +886-4-2406 5612

Website: www.chardermedical.com E-mail: info_cec@charder.com.tw

Copyright© Charder Electronic Co., Ltd. All rights reserved.

This user manual is protected by international copyright law. All content is licensed, and usage is subject to written authorization from Charder Electronic Co., Ltd. (hereinafter Charder) Charder is not liable for any damage caused by a failure to adhere to requirements stated in this manual. Charder reserves the right to correct misprints in the manual without prior notice, and modify the exterior of the device for quality purposes without customer consent.



Charder Electronic Co., Ltd.
No. 103, Guozhong Rd., Dali Dist.,
Taichung City, 412 Taiwan

CONTENTS

I. Safety Notes	5
A. General Information	5
B. EMC Guidance and Manufacturer's Declaration	8
II. Installation.....	12
A. General Warnings.....	12
B. Inserting Batteries	15
III. Indicator and Key Functions	16
IV. Using Device	18
A. Basic Operation	18
B. Hold	18
C. BMI (3-key model)	19
D. Tare	19
V. Device Setup	20
VI. Troubleshooting.....	22
VII. Product Specifications.....	25
A. Device Information	25
B. Technical Data for Joints	26
VIII. Declaration of Conformity	28



I. Safety Notes

A. General Information

Thank you for choosing this Charder Medical device. It is designed to be easy and straightforward to operate, but if you encounter any problems not addressed in this manual, please contact your local Charder service partner.

Before beginning operation of the device, please read this user manual carefully, and keep it in a safe place for reference. It contains important instructions regarding installation, proper usage, and maintenance.

Intended Use

This device is intended to measure the weight of subjects with limited mobility, for diagnosis of weight-related issues by professionals.

General Handling

- Ensure all parts are properly locked and tightened before operating the device.

Safety Instructions

Before putting device into use, please read this user manual carefully. It contains important instructions for installation, usage, and maintenance of device.

The manufacturer shall not be liable for damages caused by failure to heed the following instructions:

- Batteries should be kept away from children. If swallowed, promptly seek medical assistance.
- Expected service life: 5 years.
- Always comply with appropriate regulations when using electrical components under increased safety requirements.
- Improper installation will render the warranty null and void.
- The device is intended for indoor use only.
- Observe permissible ambient temperatures for use
- Device meets requirements for electromagnetic compatibility. Do not exceed the maximum values specified in the applicable standards.
- This device should only be attached to compatible patient lift systems

- Do not lean against device, to minimize falling risk.
- Device must not be modified. Any unauthorized modification will void warranty, and Charder is not responsible for resulting damage.
- Do not exceed maximum loading capacity.
- Maximum safe overload is 6 times maximum capacity of device. (device will beep when loading exceeds maximum capacity)

Environmental

- All batteries contain toxic compounds; batteries should be disposed of via designated competent organizations. Batteries should not be incinerated.
- The optimum operating temperature for the device is 0°C to +40°C; although it will operate at higher and lower temperatures, battery life will adversely be effected.

Cleaning

- Device surface should be cleaned using alcohol-based wipes. Corrosive cleansing liquids should not be used. Pressure-washers should not be used.
- Do not use large amounts of water when cleaning the device, as it may cause damage to the internal electronics.

Maintenance

- Please contact your local Charder distributor for regular maintenance and calibration.
- Device does not require routine maintenance. However, regular checking of accuracy is recommended; frequency to be determined by level of use and state of device. If results are inaccurate, please contact local distributor.

Warranty/Liability

- If Charder is responsible for a fault or defect present upon receipt of the unit, Charder shall either repair the fault, or supply a replacement unit. Should the repairs or replacement delivery fail, statutory provisions shall be valid. The period of warranty shall be two years, beginning on the date of purchase. Please retain your receipt as proof of purchase.
- No responsibility shall be accepted for damage caused through any of the following reasons: unsuitable or improper storage or use, incorrect installation or commissioning by the owner or third parties, natural wear and tear, changes or modifications, incorrect or negligent handling, chemical, electrochemical, or electrical interference, unless damage is attributable to negligence on the part

of Charder.

- This device does not contain any user-maintained parts. All maintenance, technical inspections, and repairs should be conducted by an authorized Charder service partner, using original Charder accessories and spare parts. Charder is not liable for any damages arising from improper maintenance or usage. Dismantlement of the device will void the warranty.

Disposal

- This product is not to be treated as regular household waste, but should be taken to a designated collection points for electronics. Further information should be provided by local waste disposal authorities.



Warning

- Keep device away from liquids.
- Do not under any circumstances dismantle or alter the device, as this could result in electric shock or injury as well as adversely affect the precision of measurements.
- Do not place the device in direct sunlight, or in close proximity to an intense heat source. Excessively high temperatures may damage the internal electronics.

Incident Reporting

- Any serious incident that has occurred in relation to the device should be reported to the manufacturer, EU representative (if device is used in EU member state), and competent authority of user/subject's member state.

B. EMC Guidance and Manufacturer's Declaration

Guidance and manufacturer's declaration-electromagnetic emissions		
<p>The MHS2510I/MHS2610I Lift Scale is intended for use in the electromagnetic environment specified below. The customer or the user of the device should assure that it is used in such an environment.</p>		
Emission test	Compliance	Electromagnetic environment-guidance
RF emissions CISPR 11	Group 1	The device uses RF energy only for its internal function. Therefore, its RF emissions are very low and are not likely to cause any interference in nearby electronic equipment.
RF emissions CISPR 11	Class B	The device is suitable for use in all establishments, including domestic establishments and those directly connected to the public low-voltage power supply network that supplies buildings used for domestic purposes.
Harmonic emissions IEC 61000-3-2	Class A	
Voltage fluctuations /flicker emissions IEC 61000-3-3	Compliance	

Guidance and manufacturer's declaration-electromagnetic immunity

The MHS2510I/MHS2610I Lift Scale is intended for use in the electromagnetic environment specified below. The customer or the user of the device should assure that it is used in such an environment.

Immunity test	IEC 60601 test level	Compliance level	Electromagnetic environment-guidance
Electrostatic discharge(ESD) IEC 61000-4-2	<u>± 8 kV contact</u> <u>± 2 kV, ± 4 kV,</u> <u>± 8 kV, ± 15 kV</u> <u>air</u>	<u>± 8 kV contact</u> <u>± 2 kV, ± 4 kV,</u> <u>± 8 kV, ± 15 kV</u> <u>air</u>	Floors should be wood, concrete or ceramic tile. If floors are covered with synthetic material, the relative humidity should be at least 30%
Electrical fast transient/burst IEC 61000-4-4	± 2kV for power supply lines + 1kV for input/output lines	+ 2kV for power supply lines + 1kV for input/output lines	Mains power quality should be that of a typical commercial or hospital environment.
Surge IEC 61000-4-5	± 1kV line(s) to line(s) ± 2kV line(s) to earth	+ 1kV line(s) to line(s) + 2kV line(s) to earth	Mains power quality should be that of a typical commercial or hospital environment.
Voltage Dips, short interruptions and voltage variations on power supply input lines IEC 61000-4-11	<u>0% UT for 0,5 cycle</u> <u>0% UT for 1 cycle</u> <u>70% UT(30% dip in UT) for 25 cycles</u> <u>0% UT for 5 s</u>	<u>0% UT for 0,5 cycle</u> <u>0% UT for 1 cycle</u> <u>70% UT(30% dip in UT) for 25 cycles</u> <u>0% UT for 5 s</u>	Mains power quality should be that of a typical commercial or hospital environment. If the user of the device requires continued operation during power mains interruptions, it is recommended that the device be powered from an uninterruptible power supply or a battery.
Power frequency(50/60 Hz) magnetic field IEC 61000-4-8	<u>30 A/m</u>	<u>30 A/m</u>	The device power frequency magnetic fields should be at levels characteristic of a typical location in a typical commercial or hospital environment.

NOTE UT is the a.c. mains voltage prior to application of the test level.

Guidance and manufacturer's declaration-electromagnetic immunity

The MHS2510I/MHS2610I Lift Scale is intended for use in the electromagnetic environment specified below. The customer or the user of the device should assure that is used in such an environment.

Immunity test	IEC 60601 test level	Compliance level	Electromagnetic environment-guidance
<p>Conducted RF IEC 61000-4-6</p> <p>Radiated RF IEC 61000-4-3</p>	<p>3 Vrms 150 KHz to 80 MHz</p> <p><u>6 V in ISM bands between 0,15 MHz and 80 MHz</u> <u>80 % AM at 1 kHz</u></p> <p>3 V/m 80MHz to 2,7 GHz</p>	<p>3 Vrms 150 KHz to 80 MHz</p> <p><u>6 V in ISM bands between 0,15 MHz and 80 MHz</u> <u>80 % AM at 1 kHz</u></p> <p>3 V/m <u>80MHz to 2,7 GHz</u></p>	<p>Portable and mobile RF communications equipment should be used no closer to any part of the device including cables, than the recommended separation distance calculated from the equation applicable to the frequency of the transmitter.</p> <p>Recommended separation distance: $d = 1,2 \sqrt{P}$ $d = 1,2 \sqrt{P}$ 80MHz to 800 MHz $d = 2,3 \sqrt{P}$ 800MHz to 2,5 GHz</p> <p>Where P is the maximum output power rating of the transmitter in watts (W) according to the transmitter manufacturer and d is the recommended separation distance in metres (m).</p> <p>Field strengths from fixed RF transmitters, as determined by an electromagnetic site survey^a, should be less than the compliance level in each frequency range^b.</p> <p>Interference may occur in the vicinity of equipment marked with the following symbol:</p> <div style="text-align: center;">  </div>

NOTE1 At 80 MHz and 800 MHz, the higher frequency range applies.

NOTE2 These guidelines may not apply in all situations. Electromagnetic propagation is affected by absorption and reflection from structures, objects and people.

- a Field strengths from fixed transmitters, such as base stations for radio (cellular/cordless) telephones and land mobile radios, amateur radio, AM and FM radio broadcast and TV broadcast cannot be predicted theoretically with accuracy. To assess the electromagnetic environment due to fixed RF transmitters, an electromagnetic site survey should be considered. If the measured field strength in the location in which the device is used exceeds the applicable RF compliance level above, the device should be observed to verify normal operation. If abnormal performance is observed, additional measures may be necessary, such as re-orienting or relocating the device.
- b Over the frequency range 150 kHz to 80 MHz, field strengths should be less than 3 V/m.

Recommended separation distance between portable and mobile RF communications equipment and the MHS2510I/MHS2610I Lift Scale

The device is intended for use in an electromagnetic environment in which radiated RF disturbances are controlled. The customer or the user of the device can help prevent electromagnetic interference by maintaining a minimum distance between portable and mobile RF communications equipment (transmitters) and the device as recommended below, according to the maximum output power of the communications equipment.

Rated maximum output power of transmitter W	Separation distance according to frequency of transmitter m		
	150 kHz to 80 MHz $d = 1,2\sqrt{P}$	80 MHz to 800 MHz $d = 1,2\sqrt{P}$	800 MHz to 2,5 GHz $d = 2,3\sqrt{P}$
0,01	0,12	0,12	0,23
0,1	0,38	0,38	0,73
1	1,2	1,2	2,3
10	3,8	3,8	7,3
100	12	12	23

For transmitters rated at a maximum output power not listed above, the recommended separation distance d in metres (m) can be estimated using the equation applicable to the frequency of the transmitter, where p is the maximum output power rating of the transmitter in watts (W) according to the transmitter manufacturer.

NOTE1 At 80 MHz and 800 MHz, the separation distance for the higher frequency range applies.

NOTE2 These guidelines may not apply in all situations. Electromagnetic propagation is affected by absorption and reflection from structures, objects and people.

II. Installation

A. General Warnings

To ensure safety, correct assembling procedure must be followed.

Tools required: hexagon screwdriver, torque wrench

1. Hold one side of device securely
2. Secure screws from other side. Repeat for both sides (ex: first secure left, then right, or vice versa).

NOTE: torque setting must be $18\text{kgf}\cdot\text{cm} \pm 1\text{kgf}\cdot\text{cm}$

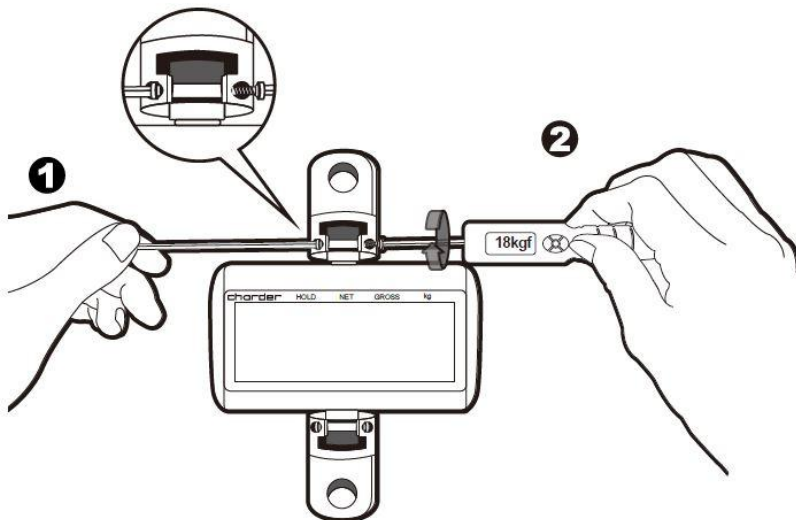

3. DO NOT use lift scale if screws are loose
4. Screws must be fully tightened before use

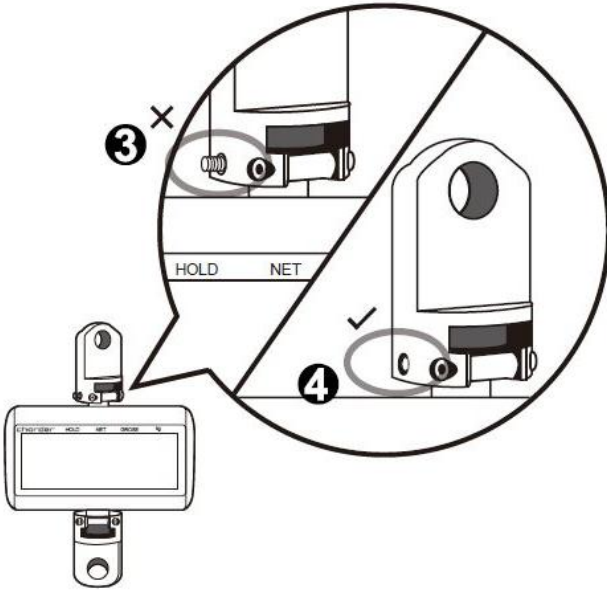

Set Screws

Set screws are used to fix direction of lift scale, and should not be loosened. Ensure screws are tight before use.

Set screw

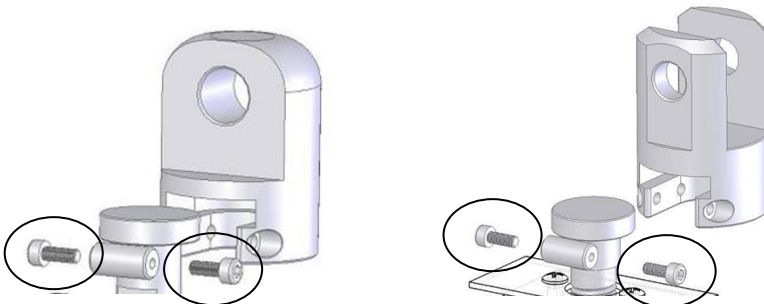
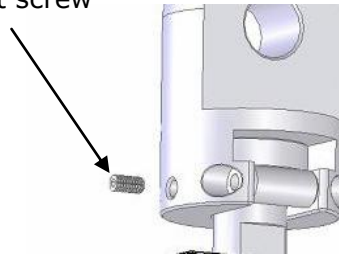

Tilt angle

Tilt angle exceeding 3 degrees will result in inaccurate reading.

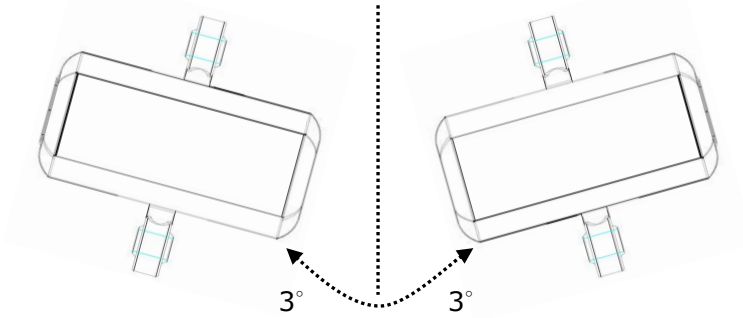

Horizontal rotation

Although not strictly necessary, device should ideally be installed on lift system utilizing 360-degree swivel bearing. After assembly at lifter, rotation should ideally be conducted using lift system rather than device.

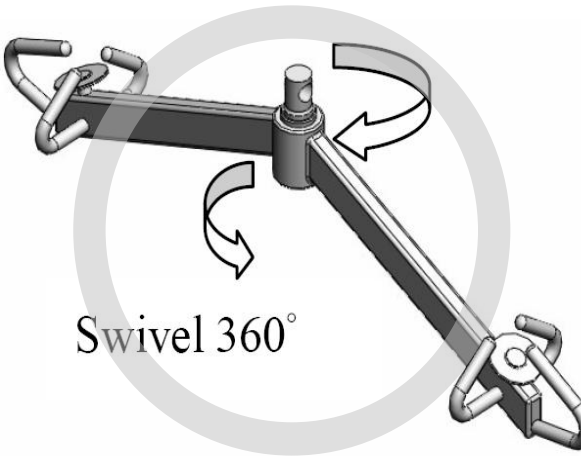

B. Inserting Batteries

1. Locate battery cover at rear of device

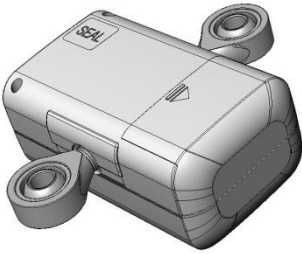

2. Remove battery cover

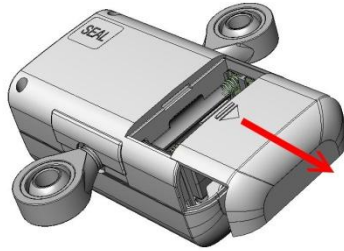

3. Remove battery case

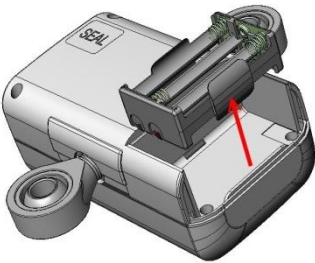

4. Insert batteries

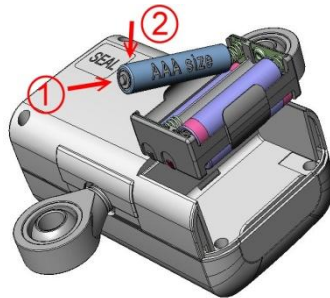

5. Insert battery case

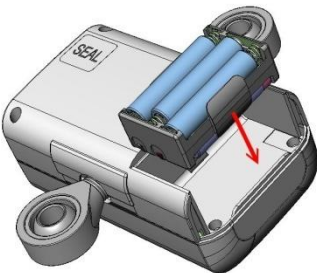



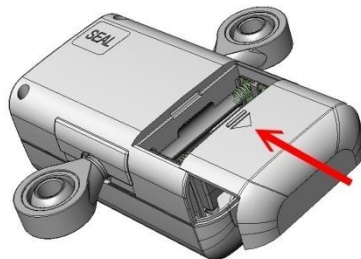

6. Replace battery cover

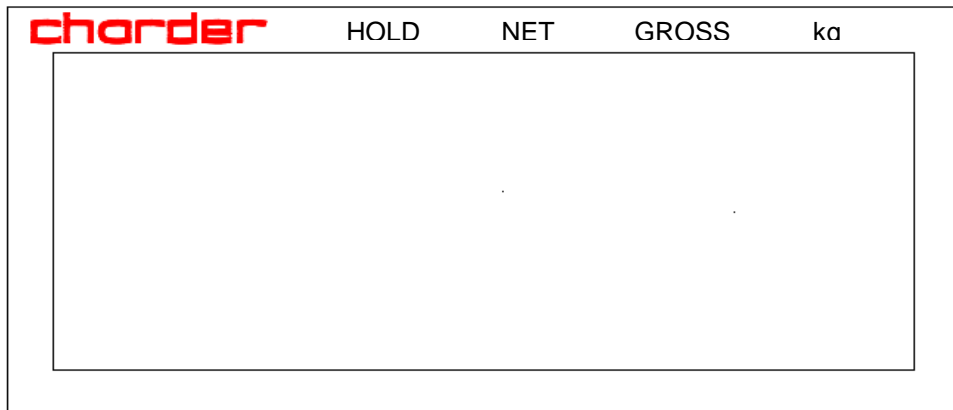

III. Indicator and Key Functions



Display

- : Stable
- : Negative weight
- : Zero
- : Low battery

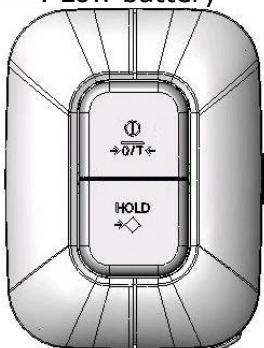

Key Function (2-key model)

1. **ON/OFF/O/T**: Power on or power off. Reset display to 0.0 kg display (can be used if within $\pm 2\%$ of full capacity). Press and hold for 3 seconds to turn off.
2. **HOLD**: Determine stable weighing value - used when weight is unstable. Press and hold for 3 seconds to enter settings.

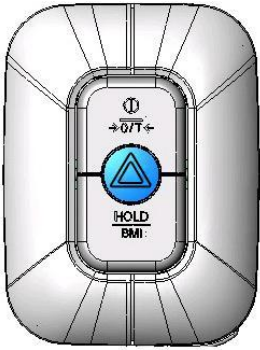

Key Function (3-key model)

1. **ON/OFF/O/T**: Power on or power off. Reset display to 0.0 kg display (can be used if within $\pm 2\%$ of full capacity). Press and hold for 3 seconds to turn off.
2. **HOLD/BMI**: Determine stable weighing value - used when weight is unstable. Press and hold for 3 seconds to enter settings.
3. **SETUP**: Enter device settings

Indicator

1. HOLD: indicates if hold is active
2. NET: indicates if current result is net weight
3. GROSS: indicates if current result is gross weight
4. kg: indicates if results are in kg

IV. Using Device

A. Basic Operation

Switch on the device using **[ON/OFF/O/T]** key. The device will automatically perform self-calibration, displaying software version.

Once "0.00 kg" appears on indicator, device is ready for measurement.

Note: If "0.00 kg" does not display on indicator, press **[ON/OFF/O/T]** key to zero the device. This function can be used for weight within $\pm 2\%$ of full capacity.

Guide subject to sit upon sling (or other device connected to lift). After the weight has stabilized, the "stable" symbol will appear on indicator.

Note: If subject's weight exceeds scale capacity (including tare), indicator will display "Err" prompt due to overload.

B. Hold

The hold function determines average weight, designed to be used if subject's weight will not stabilize (ex: an active child).

Note: if fluctuation is too severe, average weight determination will be difficult and hold may not function correctly

1. Switch on the device normally.
2. Press the **[HOLD]** key (HOLD/BMI on 3-key model). "HOLD" will be displayed on the indicator.
3. Conduct measurement as usual.
4. After a few seconds, the average weight will be displayed on the indicator. This weight will be locked - at this point, subject can step off from device.
5. To release the locked weight, press the **[HOLD]** key (HOLD/BMI on 3-key model) again to return to the device to normal mode.

Note: Hold function can be activated before or after subject stands on measurement platform. However, if subject finds it difficult to stand still, we recommend activating Hold after subject stands on platform.

C. BMI (3-key model)

1. In normal mode, press and hold **[HOLD/BMI]** key to enter BMI mode.
2. Display will show last recorded height. Digits will flash.
3. Press **[ON/OFF/O/T]** key to increase, **[△]** to decrease. Press and hold to speed up.
4. After inputting height, press **[HOLD/BMI]** to confirm.
5. Proceed to weigh subject as usual. Indicator will display weight, height, and BMI.

NOTE: Hold function can be used at this time if weight is unstable

6. Press **[HOLD/BMI]** key to return to normal mode.

Category	BMI (kg/m ²)	Risk of obesity-related disease
Under	< 18.5	Low
Normal	18.5-24.9	Average
Over	24.9-29.9	Slightly Increased
Obese I	30.0-34.9	Increased
Obese II	35.0-39.9	High
Obese III	> 40	Very High

(World Health Organization adult BMI standards)

NOTE: though BMI is calculated in the same way, subjects under the age of 18 should use separate standards for interpretation, in comparison with percentile charts for their age group.

D. Tare

The tare function allows the user to deduct the weight of objects from the device's measurement result.

1. Place object that needs to be tared onto sling.
2. Press **[ON/OFF/O/T]** key after stable symbol appears on indicator. Display will indicate "0.00 kg".
3. Guide subject (plus tared object) to be weighed upon sling. Conduct measurement.
4. To clear tare value, remove all objects from measurement platform, and press **[ON/OFF/O/T]** key.

V. Device Setup

2-key model

When the device is switched on, press and hold the **[HOLD]** key for about 3 seconds, until the display shows the "SETUP", followed by "A_OFF" (first option in setting menu).

In device setup menu:

[HOLD] to toggle next menu option

[ON/OFF/O/T] to confirm selection / enter submenu

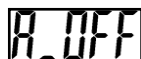
A rectangular LCD display showing the text "A_OFF" in a digital font.

Auto Power-Off: Instruct device to shut off automatically after a certain period of time.

Auto off options: 120 sec / 180 sec / 240 sec / 300 sec / off

Press **[HOLD]** to toggle between time options, and **[ON/OFF/O/T]** to confirm selection.

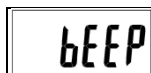
A rectangular LCD display showing the text "BEEP" in a digital font.

Buzzer/Beep:

When function is turned on, beeping noise will be made when: indicator is turned on, keys are pressed, and weight is stable.

Press **[HOLD]** to toggle between on/off, and **[ON/OFF/O/T]** key to confirm selection.

3-key model

When the device is switched on, press and hold the \triangle key for about 3 seconds, until the display shows the "SETUP", followed by "A_OFF" (first option in setting menu).

In device setup menu:

[HOLD/BMI] to toggle next menu option

[ON/OFF/O/T] to confirm selection / enter submenu

A rectangular LCD display showing the text "A_OFF" in a digital, segmented font.

Auto Power-Off: Instruct device to shut off automatically after a certain period of time.

Auto off options: 120 sec / 180 sec / 240 sec / 300 sec / off

Press **[HOLD/BMI]** to toggle between time options, and **[ON/OFF/O/T]** to confirm selection.

A rectangular LCD display showing the text "BEEP" in a digital, segmented font.

Buzzer/Beep:

When function is turned on, beeping noise will be made when: indicator is turned on, keys are pressed, and weight is stable.

Press **[HOLD/BMI]** to toggle between on/off, and **[ON/OFF/O/T]** key to confirm selection.

VI. Troubleshooting

Product Defects

Charder's warranty is effective for the original purchaser of this device, subject to the terms and conditions listed in the Warranty Program & Return Policy.

1. If Charder is responsible for a fault or defect present upon receipt of the unit, Charder shall either repair the fault, or supply a replacement unit. Should the repairs or replacement delivery fail, statutory provisions shall be valid. The period of warranty shall be two years, beginning on the date of purchase. Please retain your receipt as proof of purchase.
2. No responsibility shall be accepted for damage caused through any of the following reasons: unsuitable or improper storage or use, incorrect installation or commissioning by the owner or third parties, natural wear and tear, changes or modifications, incorrect or negligent handling, chemical, electrochemical, or electrical interference, unless damage is attributable to negligence on the part of Charder.

If device is not covered under warranty, a service maintenance charge will apply, plus cost of replacement parts.

Before contacting your local Charder distributor for repair service, we recommend considering the following troubleshooting procedures:

Self-inspection

1. Device will not power on

- If battery power is depleted, replace with new batteries

2. Indicator showing "0000" ZERO SPAN out of range

- Interference due to factors such as RF disturbance or ground vibration. Relocate device to location without interference and try again
- External objects interfering with device. Clear area of interfering objects and try again
- If the steps above cannot resolve the problem, re-calibration may be required to correct weighing accuracy

Distributor support required

If the following errors occur, we recommend contacting your local Charder distributor for repair or replacement services:





1. Device will not power on

- Faulty on/off key
- Broken or damaged wires causing short circuit or faulty connection
- Safety fuse burnout

2. Indicator damage

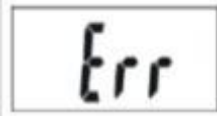
- Possible hardware defects include: uneven brightness in LCD screen, blurred text, smeared rainbow screen, incorrect decimal display
- Unable to save or read data
- Indicator shows "ERRL" after device is switched on
- Keys not responding
- Buzzer malfunction

Error Messages

Error Message	Reason	Action
	Low battery warning Voltage of battery is too low to operate device	Replace batteries
	Overload Total load exceeds device's maximum capacity	Reduce weight on measurement platform and try again
	Counting Error Signal from loadcells too low	Error normally caused by faulty loadcell or wiring. Please contact distributor
	Zero count over calibration zero range +10% while power on	Re-calibration required. Please contact distributor
	Zero count under calibration zero range -10% while power on	Re-calibration required. Please contact distributor
	Program Error Fault with device software	Please contact distributor

VII. Product Specifications

A. Device Information

Model		MHS2510I / MHS2610I	
Weight Measurement	Capacity	300 kg x 0.1 kg	400 kg x 0.2 kg
	Accuracy	± 150g	± 300g
	OIML	Class III	
	LCD Screen	1.0-inch LCD screen (5 1/2 digits)	
Dimensions	Overall	122(W) x 52(D) x 180(H) mm	
	Device Weight	1.04 kg	
Key Functions		On/Off/Zero/Tare, Hold, BMI (3-key model)	
Power Supply		6 AAA batteries	
Operation Temperature & Humidity		0°C~40°C 15% / 85% RH	
Optional Accessories			
Standard Accessories			

B. Technical Data for Joints

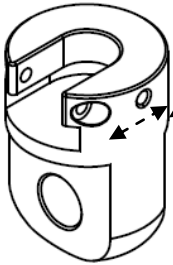
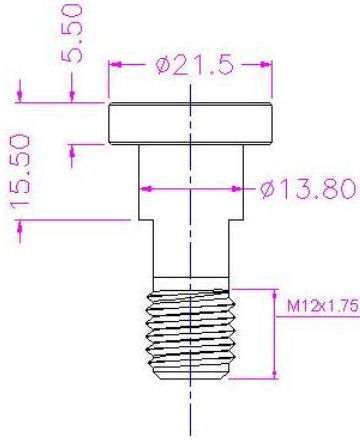
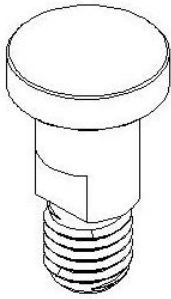

SS-6381 16mm
 SS-6384 13mm
 SS-6385 12mm

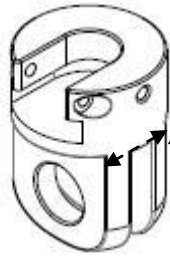

SS-7121 18.5mm

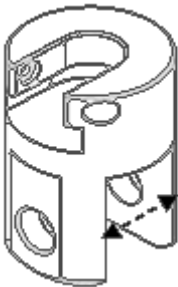

SS-6662 14mm
 SS-6663 24mm
 SS-6664 30mm
 SS1-0681 24mm
 SS1-0691 29mm

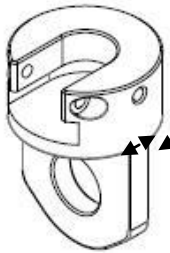

SS-7122 6mm

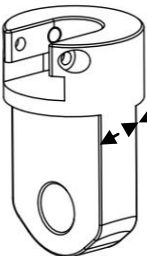

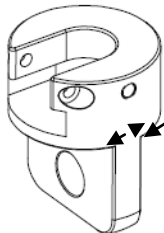

SS1-0641 12mm



SS-00058 7.7mm

VIII. Declaration of Conformity

This product has been manufactured in accordance with the harmonized European standards, following the provisions of the below stated directives:

	93/42/EEC as amended by 2007/47/EC Medical Device Directive
	2014/31/EU Non-automatic Weighing Instruments Directive

Please see separate document showing on sticker of device for above CE marking.

Authorized EU Representative:



Obelis s.a.

Bd Général Wahis, 53
B-1030 Brussels
Belgium



Manufactured by:
Charder Electronic Co., Ltd.
No.103, Guozhong Rd., Dali Dist.,
Taichung City, 412 Taiwan (R.O.C.)

CD-IN-1191 REV XXX 06/2020